

RT42/S
42 LBS THRUST
12 VOLT
36" SHAFT

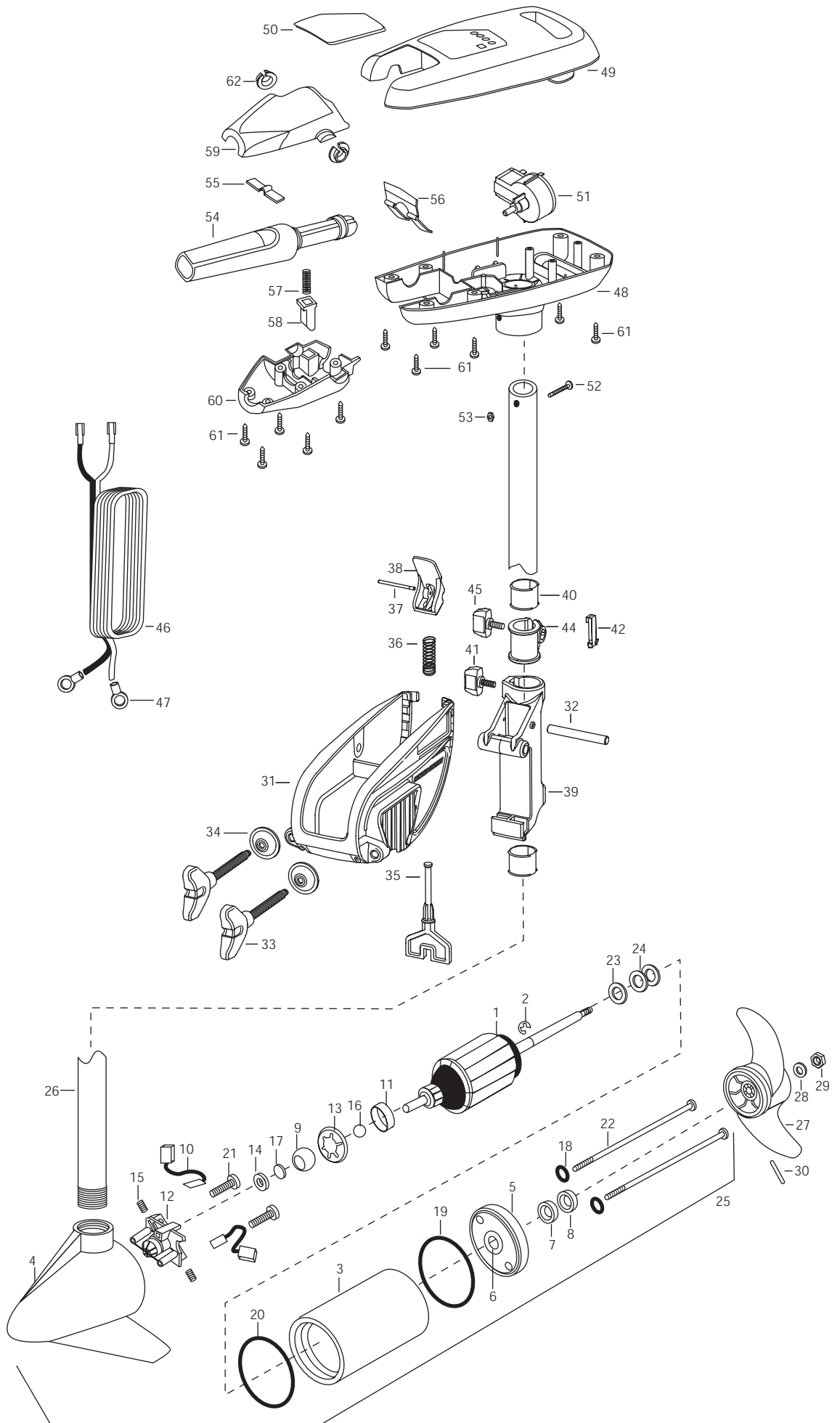

1	2-100-001	ARM ASSEMBLY12V 3.25 40*	■	1378121	PROP KIT	50	2095680	DECAL-COVER (RT42/S)
2	788-015	RETAINING RING	27	2061121	PROPELLER- 3.25 HUB DIA	51	2064023	SWITCH-FWD/REV 5 SP
3	431-379	HOUSING ASSEMBLY CENTER 3.62 WHI	28	2151726	WASHER-PROP 5/16 STD SS	52	2332102	SCREW-10-24 X 1-3/4 SS
4	2-300-332	HOUSING BRUSH END 3.25 SPCO	29	2198400	ANODE- ZINC 3.25/3.62 LWR U	53	2333101	NUT-HEX NYLOC
5	2-400-127	PLAIN END HOUSING 3.25	30	2092600	PIN-DRIVE SS	54	2990911	HANDLE ASSY-W/U-JOINT 5SPD
6	144-049	BEARING - FLANGE [SERVICE ONLY]	■	2771811	BRACKET & HINGE ASSEMBLY	55	2302742	SPRING-DETENT (OFF) SS
7	880-003	**SEAL	■	2771910	BRACKET ASSEMBLY	56	2302743	SPRING-DETENT HANDLE-TILT
8	880-006	**SEAL WITH SHIELD			(INCL- 31,33,34)	57	2302745	SPRING-RELEASE BUTTON SS
9	144-050	BEARING - SPHERICAL	*31	2061910	BRACKET PLASTIC	58	2303720	RELEASE BUTTON-HANDLE
10	188-052	BRUSH ASSEMBLY [2.EA]	32	2060511	PIN-HINGE SS	59	2060410	HANDLE (TOP HALF)NO MAXIM
11	725-033	BRUSH RETENTION- PAPER TUBE	*33	2061301	SCREW-CLAMP SS [2.EA]	60	2060415	HANDLE (LOWER HALF)
12	738-030	BRUSH PLATE W/HOLDER 3.25	*34	2331700	WASHER-CLAMP SCREW [2.EA]	61	2303412	SCREW-6-20 X 5/8 [11.EA]
13	784-036	BEARING RETAINER	35	2063605	T-BAR PLASTIC	62	2060005	BEARING-HANDLE PIVOT [2.EA]
14	991-025	WASHER - FELT	36	2062706	SPRING- T-BAR			
15	975-032	SPRING - COMPRESSION [2.EA]	37	2060516	PIN- TILT LEVER			
16	116-020	BALL - STEEL	38	2067201	LEVER-TILT BLACK			
17	303-039	THRUST DISC - METAL	39	2061810	HINGE-PLASTIC			
18	701-007	**O-RING [2.EA]	40	2037301	BUSHING-HINGE [2.EA]			
19	701-039	**O-RING MK406460	41	2011386	SCREW-TENSION/NEW KNOB SS			
20	701-041	**O-RING	42	2062800	TENSION BLOCK- SNAP IN			
21	830-001	SCREW -SELF THRD 8-32X1.7 [2.EA]	44	2061520	COLLAR-DEPTH			
22	830-078	THRU BOLT 8-32 X 8.96 [2.EA]	45	2011366	SCREW-COLLAR SS [2.EA]			
23	990-067	WASHER - STEEL THRUST	46	2090600	LEADWIRE 10GA RINGS			
24	990-070	WASHER - NYLATRON [2.EA]	47	2020700	TERMINAL RING, 3/8" [2.EA]			
25	2068054	MTR ASSEMBLY 12V 3.25 5SP SW 40/W	48	2062552	CONTROL BOX PLAS W/HAND WHT			
26	2032031	TUBE (COMPOSITE) 36 WHT	49	2060264	COVER-CTRL BOX RT WHT			

****Seal & Oring Kit P/N 2883460**

* This item is part of an assembly. This item cannot be sold separately due to machining and /or assembly that is required.

P/N 2094908 REV.A 9-02

